

PV-PID-MINI-    

# ILUMEN PIDBOX MINI

# INSTALLATION MANUAL



**OMRON**



# Installation Manual Iluven PIDbox Mini v1.8

<b>1</b>	<b>Information on this manual.....</b>	<b>3</b>
1.1	Validity.....	3
1.2	Target group.....	3
1.3	Additional information.....	3
1.4	Symbols.....	3
<b>2</b>	<b>Safety.....</b>	<b>4</b>
2.1	Appropriate usage.....	4
2.2	Qualifications of skilled persons.....	4
2.3	Safety precautions.....	4
<b>3</b>	<b>Scope of delivery.....</b>	<b>5</b>
<b>4</b>	<b>Product description.....</b>	<b>5</b>
<b>5</b>	<b>Mounting.....</b>	<b>6</b>
5.1	Mounting location requirements.....	6
5.2	Mounting the Iluven PIDbox mini using the wall brackets.....	6
<b>6</b>	<b>Electrical connections.....</b>	<b>7</b>
6.1	Earth connection.....	7
6.2	Solar array and inverter (MPPT) connections.....	8
6.3	Using splitter cables.....	9
6.4	Power supply.....	12
<b>7</b>	<b>Commissioning.....</b>	<b>13</b>
7.1	Check.....	13
7.2	Starting up the Iluven PID Solution.....	13
<b>8</b>	<b>Installation summary.....</b>	<b>14</b>
<b>9</b>	<b>Decommissioning the Iluven PID Solution.....</b>	<b>16</b>
9.1	Disassembling the PIDbox mini.....	16
9.2	Packing the PIDbox mini.....	16
9.3	Disposing of the PIDbox mini.....	16
<b>10</b>	<b>Troubleshooting.....</b>	<b>17</b>
10.1	Faults.....	17
10.2	No good PID regeneration.....	17
10.3	Resetting the PIDbox mini.....	17
10.4	Repairing the PIDbox mini.....	17
<b>11</b>	<b>Contact.....</b>	<b>18</b>
<b>12</b>	<b>Technical data.....</b>	<b>19</b>



# Installation Manual Ilumen PIDbox Mini v1.8

## 1 Information on this manual

This manual contains instructions on how to install the Ilumen PIDbox mini.

### 1.1 Validity

This manual applies to the Ilumen PIDbox mini.

### 1.2 Target group



This manual is intended for skilled persons. Only qualified persons with the appropriate skills are allowed to perform the tasks set forth in this manual.

### 1.3 Additional information

Links to additional information can be found at [industrial.omron.eu](http://industrial.omron.eu) and [green.omron.eu](http://green.omron.eu)

- Ilumen PIDbox mini datasheet
- What is PID?

### 1.4 Symbols

Symbol	Explanation
	Indicates a hazardous situation which, if not avoided, will result in property damage
	Indicates a hazardous situation which, if not avoided, will result in death or serious injury
	Information that is important for a specific topic or objective, but is not safety-relevant

This concept was introduced in middle of the 1970's and is very well proven and is used in most of the variable speed drives at this moment. Still due to increased use of these kinds of drives nowadays also the limitations of such a system come more in site.

## **2 Safety**

---

### **2.1 Appropriate usage**

The Ilumen PIDbox mini applies a voltage to PV modules in reference to earth. The device may only be switched on when the installation is done as described in this manual.

Before installing the Ilumen PIDbox mini, ensure that the permitted operating range of each component is maintained at all times.

Before using the Ilumen PIDbox mini you have to obtain the appropriate approval from the manufacturer of the PV modules.

Any applications other than those described here shall be considered contrary to the appropriate usage. Alternative use or modification of the Ilumen PIDbox mini will void warranty claims and operation permit.

### **2.2 Qualifications of skilled persons**

The work described in this document must be performed by skilled personnel only. Skilled personnel must have the following qualifications:

- Knowledge of how an inverter works and how it is operated
- Training in how to deal with the dangers and risks involved in installing and operating electrical devices and plants
- Training in the installation and commissioning of electrical devices and plants
- Knowledge of all applicable standards and directives
- Knowledge and observance of this document and all safety precautions

### **2.3 Safety precautions**

#### **2.3.1 Electric shock**



When the Ilumen PIDbox mini is in operation, voltage will be present. Prior to maintenance work on the PV plant switch off the Ilumen PIDbox mini.



When you want to change the arrangement of the Ilumen PIDbox mini you must switch off the Ilumen PIDbox mini 20 minutes prior to making any changes.

#### **2.3.2 Electrostatic discharge**



Never operate the Ilumen PIDbox mini when not properly installed or when the components are not closed properly. Always make sure the grounding of the Ilumen PIDbox mini is done correctly.

### ***3 Scope of delivery***

---

1 x Ilumen PIDbox mini

1 x DC power supply

1 x Power cord (AC plug)

4 x Rubber feet

2 x Mounting bracket

1 x Installation manual

### ***4 Product description***

---

The Ilumen PIDbox mini is placed between the inverter and the solar array strings. The power of the strings goes through the PIDbox, entering on one side "PV in" and leaving on the other "Inv. out". This means the Ilumen PIDbox mini is placed in series between the PV panels and the inverter. You can use one Ilumen PIDbox mini per 2 MPP trackers.

## 5 Mounting

### 5.1 Mounting location requirements

- The installation site must be freely and safely accessible at all times without the necessity for any auxiliary equipment.
- The mounting location should be inside a rain- and windproof location.
- Do not place the Ilumen PIDbox mini in a dusty environment.
- The ambient temperature must be between -25 and 60°C.
- Normally the PIDbox mini is installed right below the inverter.
- The ideal placement is on a flat surface. Special rubber feet can be placed under the PIDbox mini to prevent scratching of any surface. Usage of the wall brackets of the Ilumen PIDbox mini is needed when no flat surface is available. Always install the box so that the power plug is pointing down.

### 5.2 Mounting the Ilumen PIDbox mini using the wall brackets

1. Mark the positions of the drill holes on the mounting surface

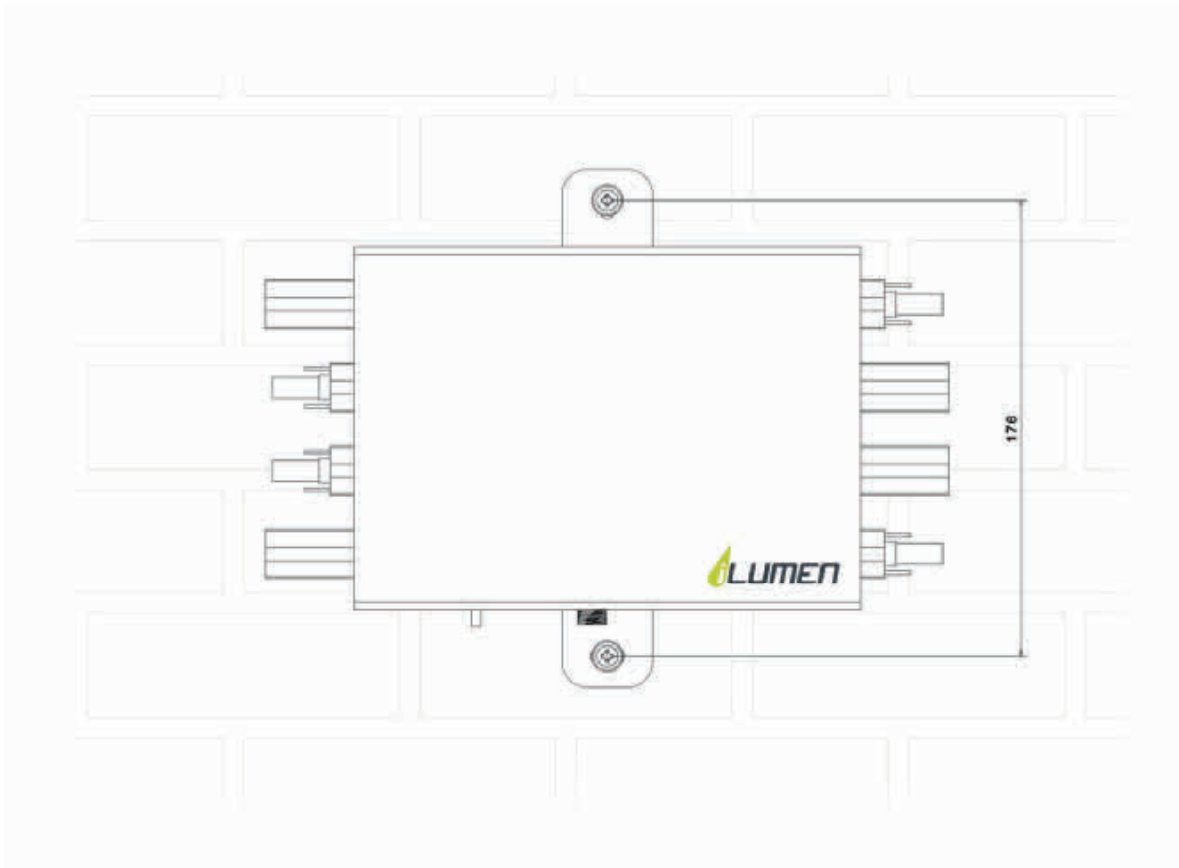

2. Drill the holes
3. Insert the wall plugs (if necessary)
4. Screw the Ilumen PID Mini to the mounting surface and make sure adequate washers are installed.



Make sure the DC power plug is pointing to the ground



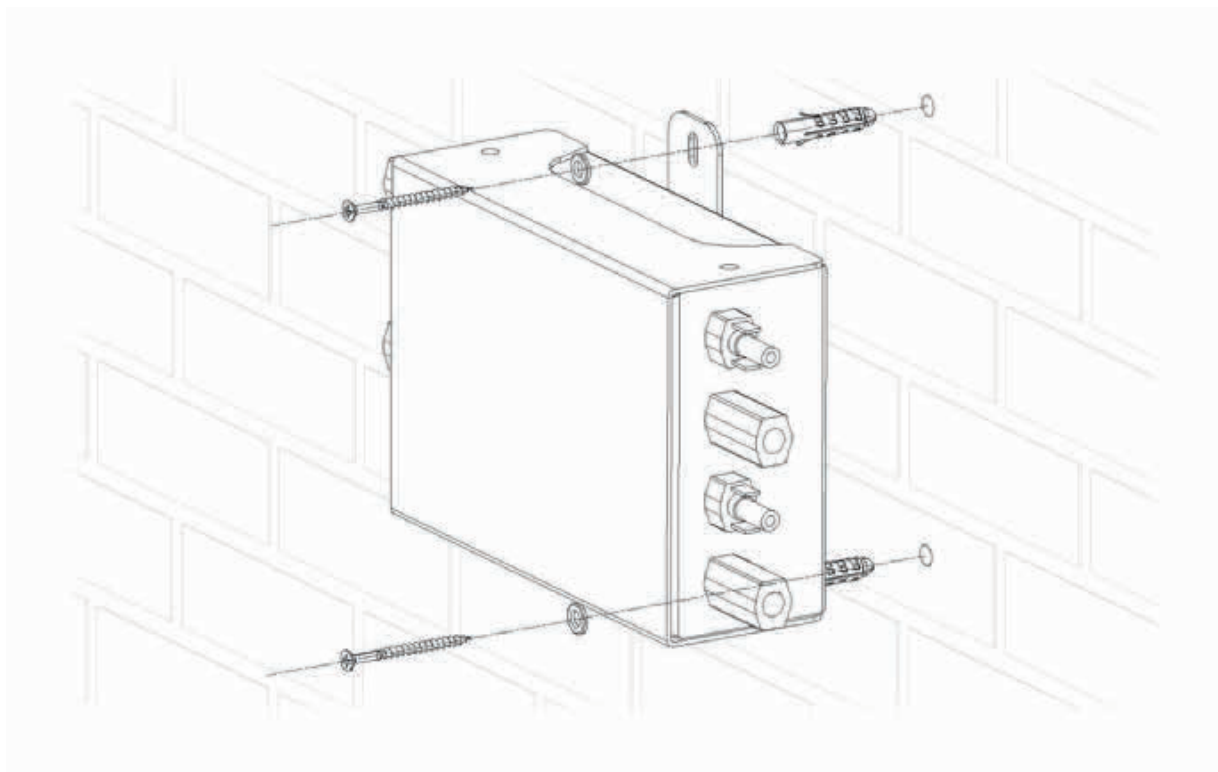

5. Check if mounted securely

## 6 Electrical connections

When installing the Ilumen PIDbox mini, the AC side of the PV plant must be switched off. Also the DC switch must be switched off. After the installation is done, you can switch the DC switch back on followed by the AC side of the PV plant.

A standard AC outlet must be available on installation. This outlet should be on at all times. The ideal solution is to have a single outlet with a single circuit breaker of 16A.

### 6.1 Earth connection

To achieve the best result, the frames of the solar modules must be connected to the earth connector of the Ilumen PIDbox mini. For optimal result you must lay a cable ( $2.5\text{--}4\text{mm}^2$ ) to the mounting structure of the solar modules (make sure mounting structures and frames of the solar modules are electrically conducting). It is important that all frames of all solar modules are at the earth potential, if necessary you have to interconnect the mounting structures with additional cables.



**6.2 Solar array and inverter (MPPT) connections**



When installing the PIDbox mini between the PV array and inverter always switch off the DC switch



When doing any kind of work on the PIDbox mini, always disconnect the DC power plug from the device before unplugging any PV-cables.

Always connect the PV arrays to the PIDbox mini. On the Illumen PIDbox mini the “A pv in +” plug should be connected to the positive side of the strings of the 1<sup>st</sup> MPPT and the “A pv in -” plug should be connected to the negative side of the strings of the 1<sup>st</sup> MPPT. The strings of a 2<sup>nd</sup> MPPT should be connected in the same manner to the “B pv in” plugs. Next connect the inverter. Connect the “A inv. out +” plug of the Illumen PIDbox mini to the positive input of the inverters 1<sup>st</sup> MPPT. Then connect the “A inv. out -” plug to the negative input of the 1<sup>st</sup> MPPT of the inverter. If “B pv in” is used connect the “B inv. out” plugs in the same manner to the inputs of the inverters 2<sup>nd</sup> MPPT.

All unused inputs and outputs have to be terminated with a corresponding sealing plug.



If you work with inverters with multiple MPPT’s you cannot mix the PV arrays from multiple MPPT’s.



The maximum current that can pass through the Illumen PIDbox mini is 20A per channel/MPPT. Make sure this is never exceeded.



Make sure the PV arrays are connected to the “A pv in” and “B pv in” side of the Illumen PIDbox mini, NEVER to the “A inv out” or “B inv out” side.

### 6.3 Using splitter cables

Each of the 2 channels of the PIDbox mini has a current limitation of 20A. There is only 1 input for each 20A channel. To create multiple inputs on 1 channel, you can use a splitter. Here we sum up the most used ways of installing a splitter. We can make a difference between inverters that have internal string fuses and those who do not have any fuses.

#### 6.3.1 Inverter with 1 mppt and string fuses

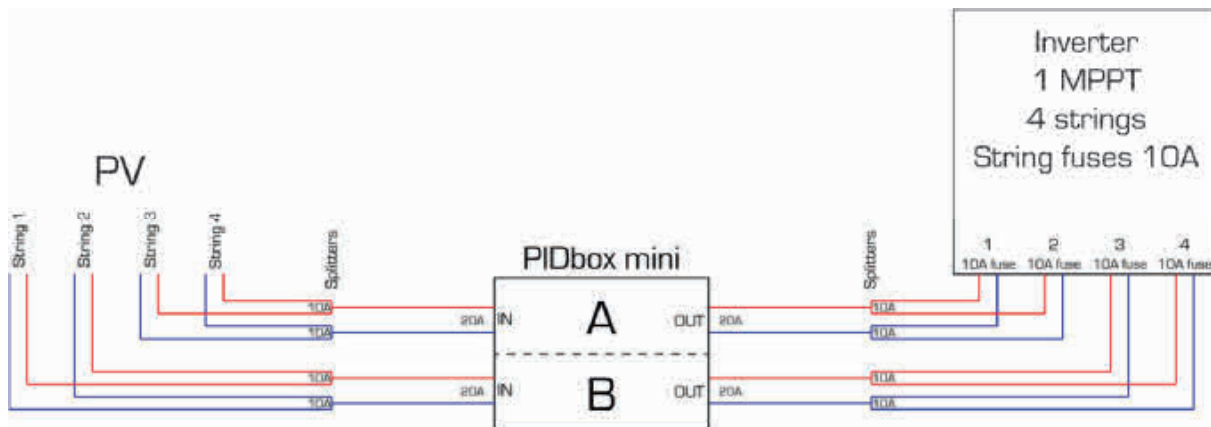

#### Inverter with 2 mppt's and string fuses

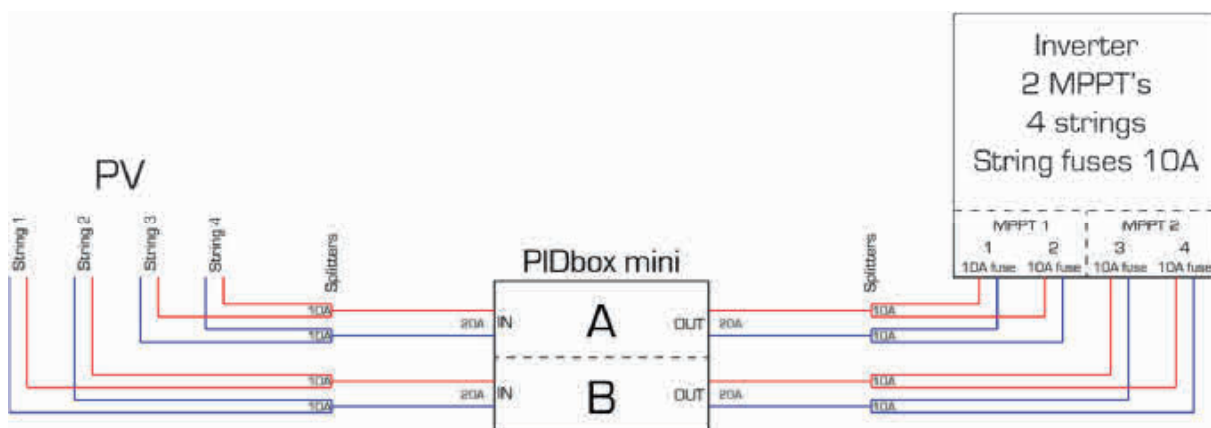

6.3.3 Inverter with 3 mppt's and string fuses

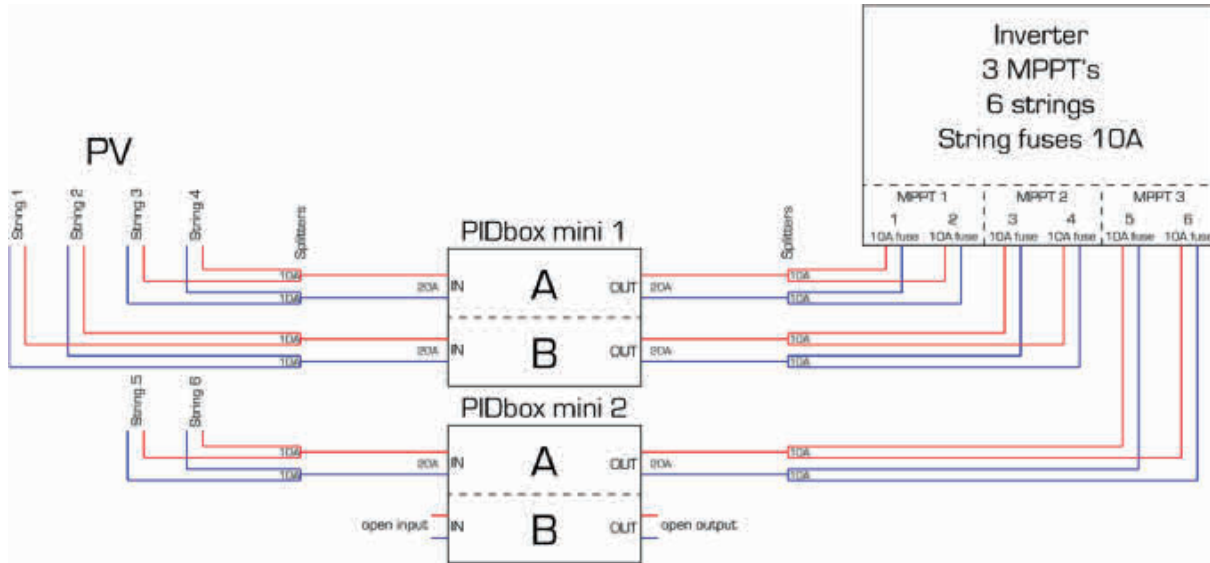

6.3.4 Inverter with 1 mppt without string fuses

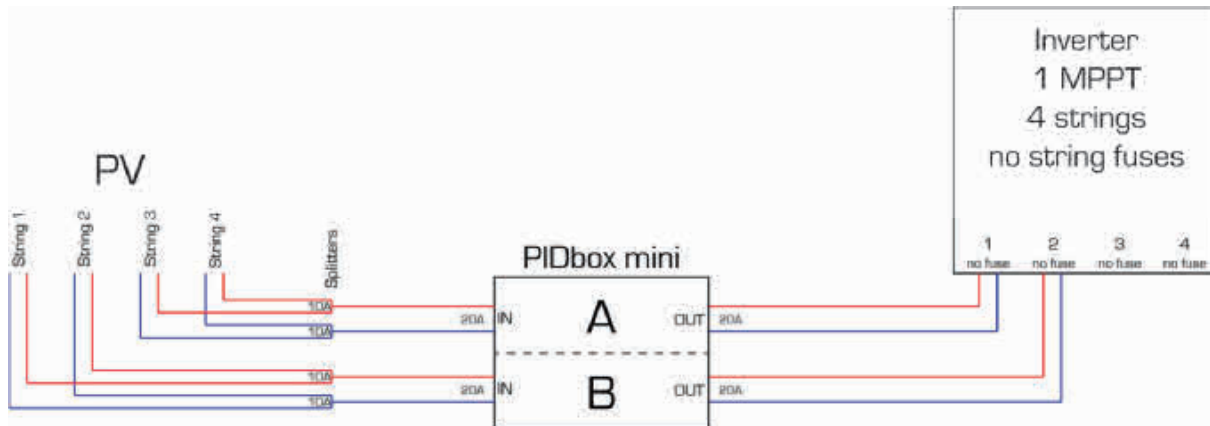

Always check the permissible current of each input of the inverter. Please consult the manufacturer of the inverter.

6.3.5 Inverter with 2 mppt's without string fuses

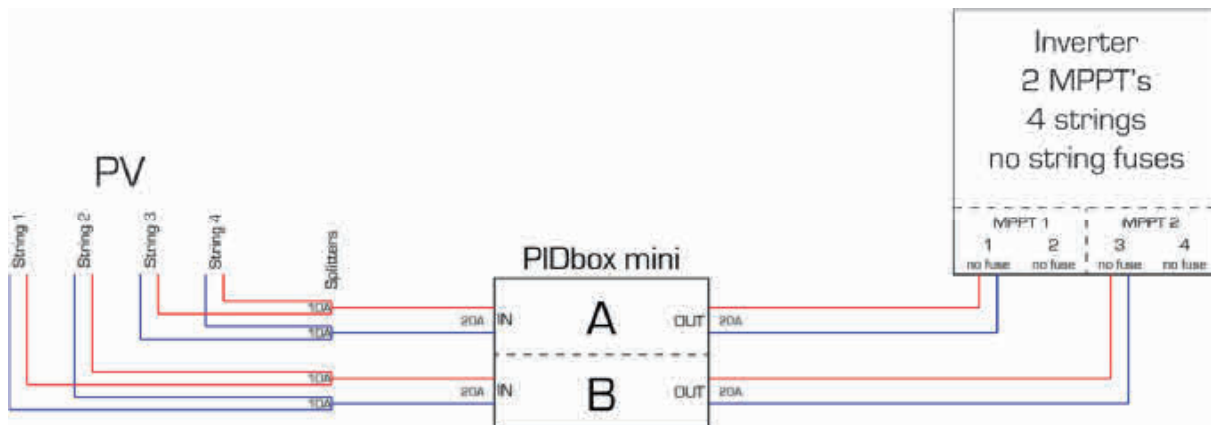

Always check the permissible current of each input of the inverter. Please consult the manufacturer of the inverter.

6.3.6 Inverter with 3 mppt's without string fuses

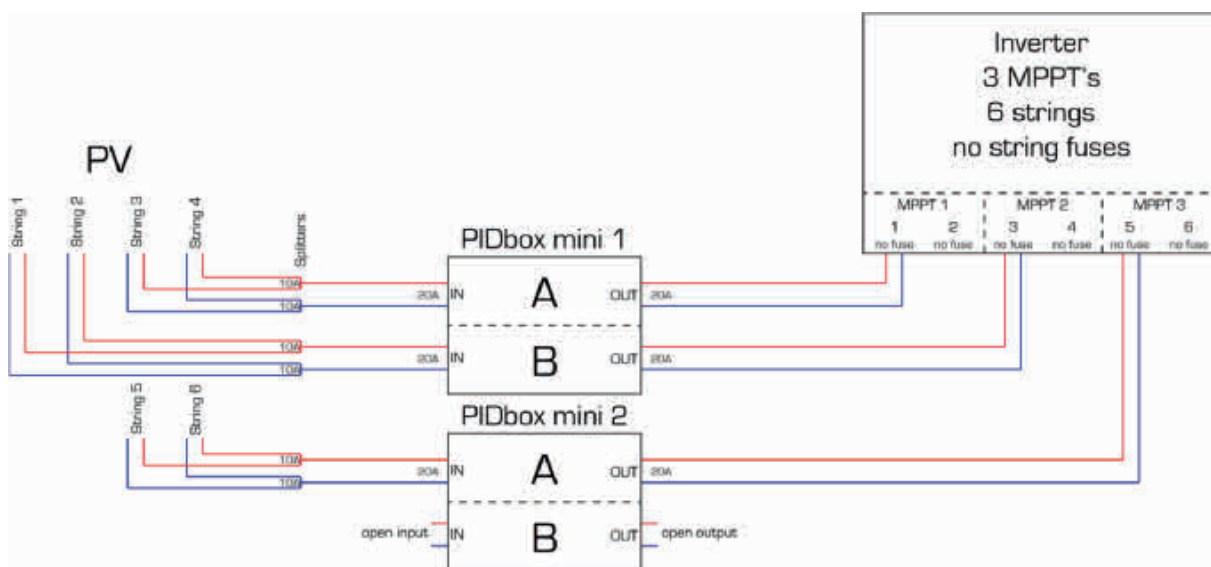

Always check the permissible current of each input of the inverter. Please consult the manufacturer of the inverter.

## 6.4 Power supply

It is important that you only use the included DC power supply. First connect its DC side to the Ilumen PIDbox mini power input. Next connect the AC side of the DC power supply to the unplugged power cord. You may connect the DC side to the Ilumen PIDbox mini during installation. Don't connect the AC side until commissioning.

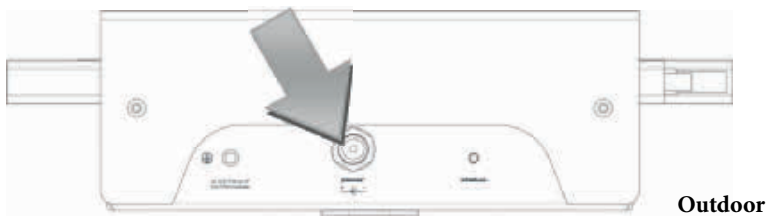
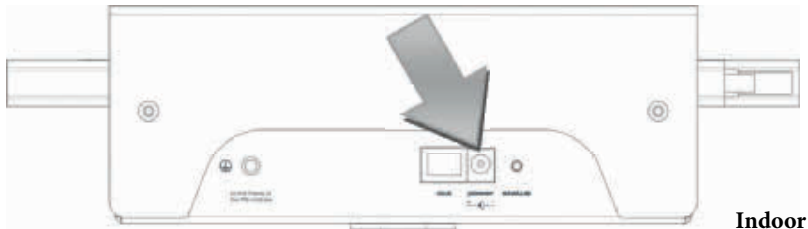

Make sure that locking screw of the DC-power plug for the outdoor version is tightened for insuring a waterproof product



Make sure you always mount the power supply itself in a dry environment eg. in the nearest inverter

## 7 Commissioning

### 7.1 Check

Do a final check whether everything is properly mounted and connected (see chapter 5 and 6 for details):

- The PV frames are all connected to the same earth as the earth pin of the Ilumen PIDbox mini
- The PV and inverter DC cables are correctly connected
- Unused DC inputs and outputs are terminated with a corresponding sealing plug
- The DC side of DC power supply is correctly connected

If all these points are installed correctly you can start up the Ilumen PIDbox mini.

### 7.2 Starting up the Ilumen PID Solution

The Ilumen PIDbox mini can only work in an automatic mode. To start up the Ilumen PIDbox mini, plug in the DC power supply into a standard AC outlet (This outlet must be on at all times). Next see if the LED light on the Ilumen PIDbox mini starts burning. After checking the system it will be switched on automatically.

When the Ilumen PIDbox mini is hooked up correctly to the inverter you will see the following status LED readouts.

- RED BLINKING: power supply connected but no active solar system detected
- BLUE: active solar system detected but no current flowing
- CYAN: active solar system detected and current flowing
- GREEN BLINKING: all startup conditions are met and PIDbox mini will start in less than 30 minutes
- RED: PIDbox mini active at night time
- PURPLE: (OUTDOOR only) purple led can burn at night time. May switch to RED



It is normal for the LED to be out at the beginning and at the end of the night

After start-up you may turn the DC switch back on, followed by the AC side of the PV plant.

## ***8 Installation summary***

---

1. Take the necessary safety precautions (AC side of the PV plant off and DC switch off).
2. Mount the Ilemen PIDbox mini on a flat surface or if not available mount it correctly to a wall using the wall bracket.
3. Connect the Ilemen PIDbox mini earth pin to the frames of the PV modules and check the interconnections between the PV casings.
4. Disconnect the PV array cables from the inverter.



Each side (A and B) has a maximum current input of 20Amps. So multiple strings can be combined to form a bigger input per side. To do this a “DC combiner cable” can be utilized.

But always mind the maximum input current of 20Amps for each side (A and B).

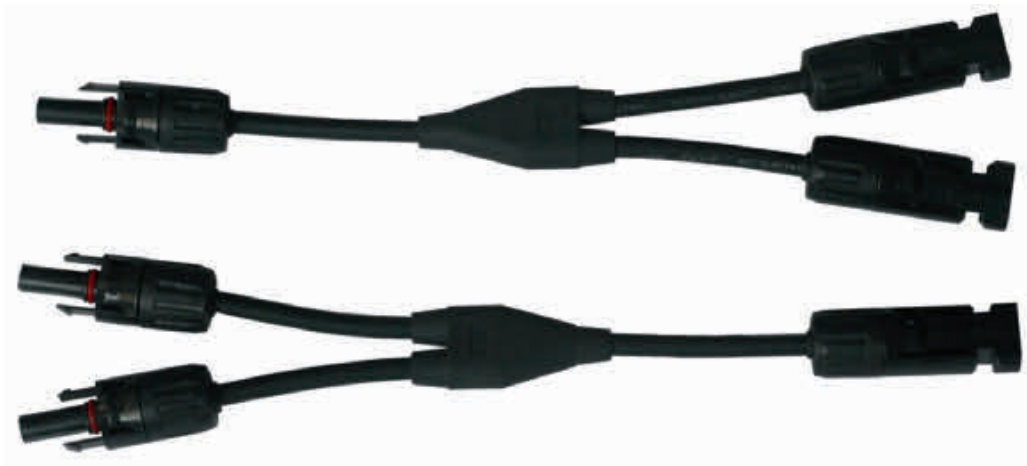



**Installation summary**

5. Connect the PV array cables to the Ilumen PIDbox mini inputs (see 6.2 for details).

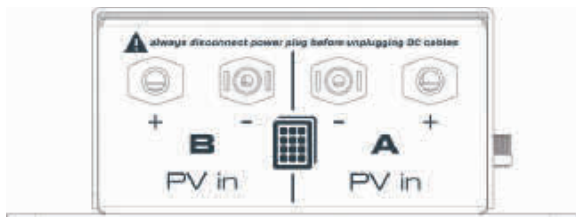

6. Connect the Ilumen PIDbox mini to the inverter (see 6.2 for details).

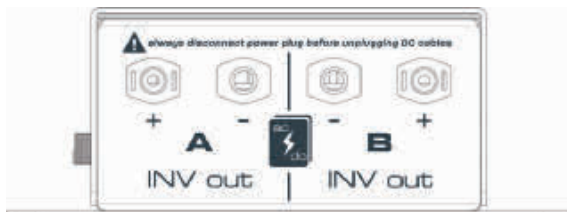

7. Connect the DC power supply to the Ilumen PIDbox mini.
8. Plug the DC power supply into an outlet (LED of the Ilumen PIDbox mini lights up if the PVs are producing electricity)

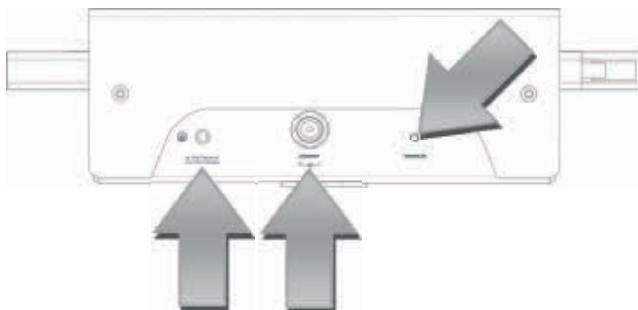

9. Turn the DC switch back on followed by the AC side of the PV plant

## ***9 Decommissioning the Ilemen PID Solution***

---

### **9.1 Disassembling the PIDbox mini**

Switch off the Ilemen PIDbox mini. Disconnect the Ilemen PIDbox mini from the AC grid. Wait for minimum 20 minutes. Make sure the AC cannot be plugged in again. Disconnect the DC switch and wait until the inverter is discharged. Disconnect all DC connectors going to the PV arrays and then disconnect the lines going to the inverter. When all electrical connections are disconnected you can dismount the Ilemen PIDbox mini.



When doing any kind of work on the PIDbox mini, always disconnect the DC power plug from the device before unplugging any PV-cables.

### **9.2 Packing the PIDbox mini**

To pack the PIDbox mini use the original packaging or packaging suitable for the weight and dimensions of the PIDbox mini (see Section 12 “Technical Data”).

### **9.3 Disposing of the PIDbox mini**

Dispose of the PIDbox mini at the end of its service life in accordance with the disposal regulations for electronic waste currently applicable at the installation site.

## 10 Troubleshooting

### 10.1 Faults

LED readout	Fault	Corrective action
No leds visible	Product does not work	Make sure the DC-power supply is plugged into a AC-outlet. Also make sure the outlet is under tension.
No leds visible	Product does work and makes some clicking noises	This can happens at dusk and dawn. LED should light up after a while. If not please contact Omron technical service.
Led gives other color than BLUE, GREEN, WHITE, CYAN, PURPLE or RED	Product does not work	Please contact Omron technical service.
No RED or PURPLE led during nighttime while during the day blue or cyan leds are burning	Curing of the panels is not working	This can have 2 reasons: <ul style="list-style-type: none"> <li>• PID is not present on PV-modules (however the first night of regeneration the led must be on).</li> <li>• Earth connection between PIDbox mini and the frame of the modules is interrupted</li> </ul>
Red led blinking during the night	Product does not work	If you connected the PIDbox when it was already dark outside, the PIDbox will not become active during that 1st night. Normally the PIDbox mini should work the nights after that when the solar plant has been active during the day.

### 10.2 No good PID regeneration

If the modules are not regenerating or not regenerating fast enough you should check following things:

- Check the grounding of the system. If necessary you should place additional interconnections between the frames of the modules.
- Is the Ilumen PIDbox mini properly connected to the grid?
- Is the DC power supply properly connected (is its indication light burning)?
- Let an expert check if the problem you're having with the yield is caused by PID

### 10.3 Resetting the PIDbox mini

The PIDbox mini can simply be reset by unplugging the DC-power cable. Wait 10 seconds and connect the DC-power cable back to the PIDbox mini.

If resetting does not help fixing your problem, please consult chapter 10.1 of this manual.

### 10.4 Repairing the PIDbox mini

Do not try to open up the PIDbox mini by yourself. The warranty will be void.

Always contact Omron technical service if your PIDbox mini is broken.

## ***11 Contact***

---

OMRON EUROPE B.V.

Wegalaan 67-69

2132 JD Hoofddorp

The Netherlands

Tel: +31 (0) 23 568 13 00

Fax: +31 (0) 23 568 13 88

industrial.omron.eu

### **Austria**

Tel: +43 (0) 2236 377 800

industrial.omron.at

### **Belgium**

Tel: +32 (0) 2 466 24 80

industrial.omron.be

### **Czech Republic**

Tel: +420 234 602 602

industrial.omron.cz

### **Denmark**

Tel: +45 43 44 00 11

industrial.omron.dk

### **Finland**

Tel: +358 (0) 207 464 200

industrial.omron.fi

### **France**

Tel: +33 (0) 1 56 63 70 00

industrial.omron.fr

### **Germany**

Tel: +49 (0) 2173 680 00

industrial.omron.de

### **Hungary**

Tel: +36 1 399 30 50

industrial.omron.hu

### **Italy**

Tel: +39 02 326 81

industrial.omron.it

### **Netherlands**

Tel: +31 (0) 23 568 11 00

industrial.omron.nl

### **Norway**

Tel: +47 (0) 22 65 75 00

industrial.omron.no

### **Poland**

Tel: +48 22 458 66 66

industrial.omron.pl

### **Portugal**

Tel: +351 21 942 94 00

industrial.omron.pt

### **Russia**

Tel: +7 495 648 94 50

industrial.omron.ru

### **South Africa**

Tel: +27 (0)11 579 2600

industrial.omron.co.za

### **Spain**

Tel: +34 902 100 221

industrial.omron.es

### **Sweden**

Tel: +46 (0) 8 632 35 00

industrial.omron.se

### **Switzerland**

Tel: +41 (0) 41 748 13 13

industrial.omron.ch

### **Turkey**

Tel: +90 212 467 30 00

industrial.omron.com.tr

### **United Kingdom**

Tel: +44 (0) 1908 258 258

industrial.omron.co.uk

### **More Omron representatives**

industrial.omron.eu

12 Technical data

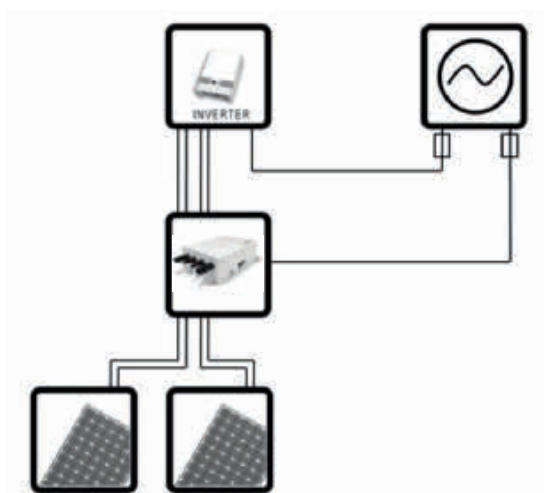

		PV-PID-MINI-ID	PV-PID-MINI-OD
PV array/inverter input	Input PV voltage range	80 to 1000 V	80 to 1000 V
	Output voltage to ground	Up to 1250 V	Up to 1250 V
	Maximum PV current	20 A	20 A
	Maximum output current in operation	5 mA	5 mA
GRID (AC)	Nominal AC voltage	100 to 240 V	100 to 240 V
	Nominal AC grid frequency	47 to 63 Hz	47 to 63 Hz
	Power consumption in standby operation	< 0.2 W	< 0.2 W
	Typical power consumption in operation	8 W	8 W
	Maximum power consumption	15 W	15 W
General data	Dimensions (W × D × H)	270×200×75 mm	270×200×75 mm
	Weight	1,100 g	1,100 g
	Operating temperature range	-25 to 60 °C (-13 to 140 °F)	-25 to 60 °C (-13 to 140 °F)
	Environmental conditions	indoor use	IP65 – indoor/outdoor use
	PV connectors	MC4 compatible	MC4 compatible
Configuration		One Ilumen PID BOX MINI per 2 MPPTs Maximum one MPPT per input (A/B) None of the connected solar module poles may become grounded on the PV side, grounding on the inverter side is possible 18 VDC power supply included	
Warranty		Standard 2 years	
Certificates		CE Declaration, EMC: EN 61000-6-3:2007, EN 61000-6-2:2005, LVD: EN50178:1997	





# OMRON

**Authorized Distributor:**