

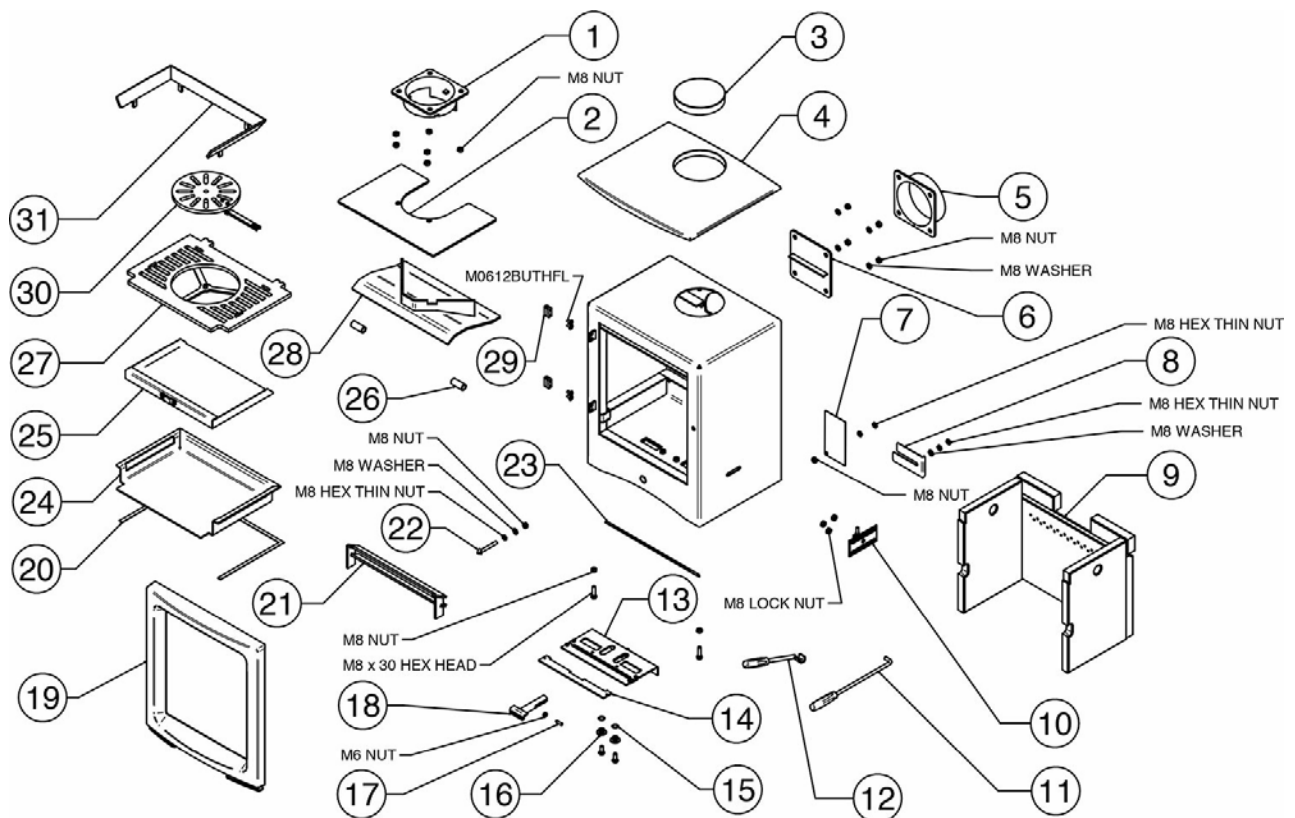

























Vogue Medium Slimline Eco – Multi Fuel (VG-MEDSLM-E)



stovaxspares.com/appliance/stoves/vogue-eco-design-stoves/vogue-medium-slimline/vogue-medium-



Read MoreRead MoreRead More

Ref.	Product Code		Description	
3	N/A Carcass		Welded Carcass Assembly	This part is not serviceable and cannot be ordered as a spare.
4	N/A Carcass		Welded Carcass Assembly	This part is not serviceable and cannot be ordered as a spare.
5	MEC10825		Vision/Vogue Small/Sheraton 5 Eco/Chesterfield 5 5" Rear Flue Adapter	
6	RVN- ME600061		Vision/Vogue/Sheraton 5 Wide Eco Rear Blanking Plate	
7	ME500717		Data Plate Mount	
8	RA504109		Vision/Vogue Medium/Sheraton 5 Wide Eco Secondary Air Control Slider	
9	N/A		See Brick Assembly Tab	This part is not currently available.
10	MEC8644		View 3/5/8/Vision/Vogue/CL3/CL5/CL8 MF Riddling Slider	
11	MEC8788		Multifunction Tool	
12	MEC8793		Ashpan Tool	
15	RVN- ME600409		Vision/Vogue O Ring	
16	ME601651		Vision/Vogue Air Control Top Hat	
17	FA500035		M6 x 20mm Spring Plunger - Single Plunger	

Ref.	Product Code		Description
18	MEC10655		Vogue Air Control Handle
19	MEC11032		Vogue Medium Eco MF Complete Door Assembly
20	4949		10mm x 2mm Self Adhesive Tape Seal - 2m Pack 850mm length required
21	MEC10927		Vision/Vogue Medium Mk2 Log Guard
22	ME601681		Vision/Vogue Medium Eco Door Latch
23	4998		20mm x 2mm Black Self Adhesive Insulation Tape - 2m Pack 437mm length required
26	ME601731		Vision/Vogue/Sheraton 5 Eco/Chesterfield 5 Baffle Extension Tube
29	MEC10682		Vision/Vogue/Sheraton 5 Eco Adjustable Door Hinge
30	MEC11028		Vision/Vogue Medium/Sheraton 5 Wide Eco Centre Grate
	M08NUTO		M8 Nut - Single Nut
	M08WASH		M8 Washer - Single Washer
	M0820HHS		M8 x 20mm Hex Head Screw - Single Screw

Ref.	Product Code	Description
RVAC111		M8 Hex Thin Nut - Single Nut
M06NUTO		M6 Nut - Single Nut







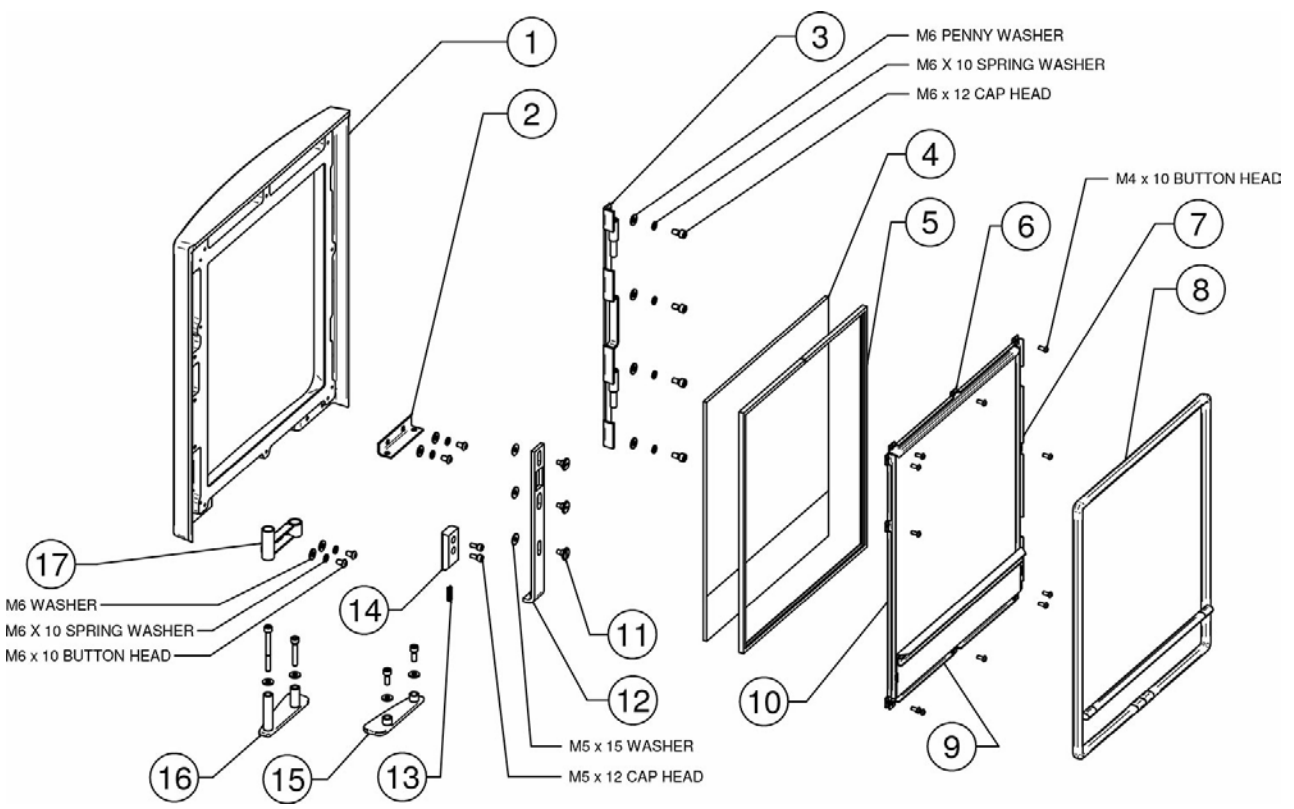





Drawing: PR10934-2

Do you have the correct appliance?

Before ordering your parts please ensure you have selected the correct appliance. To properly identify your appliance you will need to know your serial number and/or model number. Please use the following guide to help locate your data badge which contains your serial and model number information.



Ref.	Product Code	Description
1	CA7809	 Vogue Medium Eco Door Frame

Ref.	Product Code		Description
2	RA503930		Vision/Vogue Eco Door Bracket
3	MEC10736		Vision/Vogue/Sheraton 5 Hinge Plate Assembly
4	CE8300		Vogue Medium Eco MF Door Glass
5	4950		15mm x 2mm Self Adhesive Tape Seal - 2m Pack 1350mm length required
6	RA504087		Vogue Medium/Sheraton 5 Upper Door Rope Channel
8	5700		13mm Black Door Rope Seal with Adhesive - 2m Pack 1570mm length required
11	ME601628		Vogue 16mm Large Shoulder Screw
12	MEC10765		Vogue Medium Door Catch Slider
13	FA9508		6mm x 22mm Spring
14	ME601660		Vogue Door Catch Block
17	MEC10653		Vogue Door Handle Bracket
	M0410BUTH		M4 x 10mm Button Head Socket Screw - Single Screw

Ref.	Product Code	Description
	M06WASHPEN	M6 Penny Washer - Single Washer



Drawing: PR10935-2

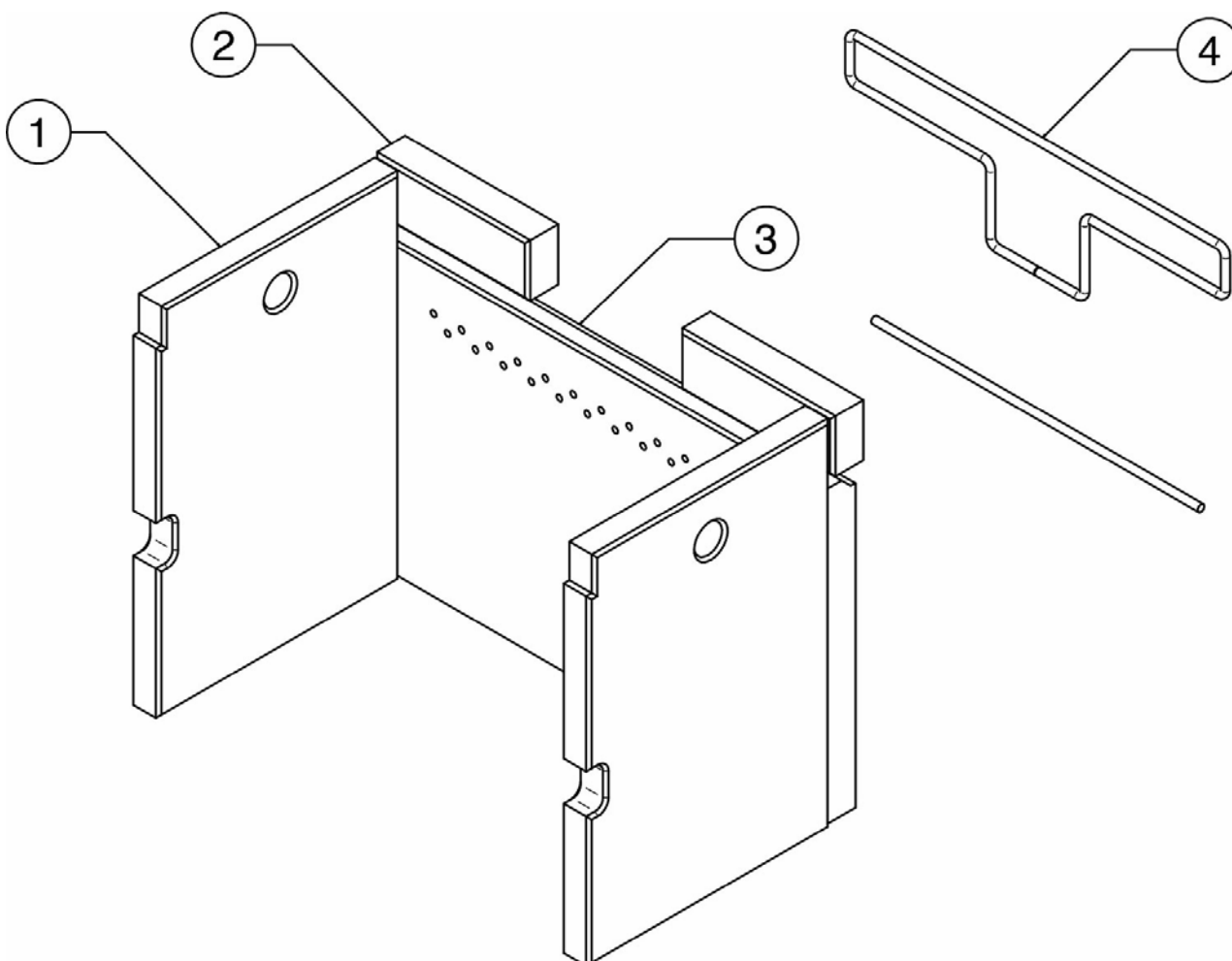

Do you have the correct appliance?

Before ordering your parts please ensure you have selected the correct appliance. To properly identify your appliance you will need to know your serial number and/or model number. Please use the following guide to help locate your data badge which contains your serial and model number information.



Ref.	Product Code	Description
1	CE8316	Vision/Vogue Medium/Sheraton 5 Wide Eco MF Side Firebrick Dimensions: 158x406x25mm



Ref.	Product Code		Description
2	CE8245		Vision/Vogue Medium/Sheraton 5 Eco Upper Rear Firebrick Dimensions: 155x65x30mm
3	CE8317		Vision/Vogue Medium/Sheraton 5 Wide Eco Lower Rear Firebrick Dimensions: 500x324x30mm
4	4947		8mm White Rope Seal with Adhesive - 2m Pack 1260mm length required



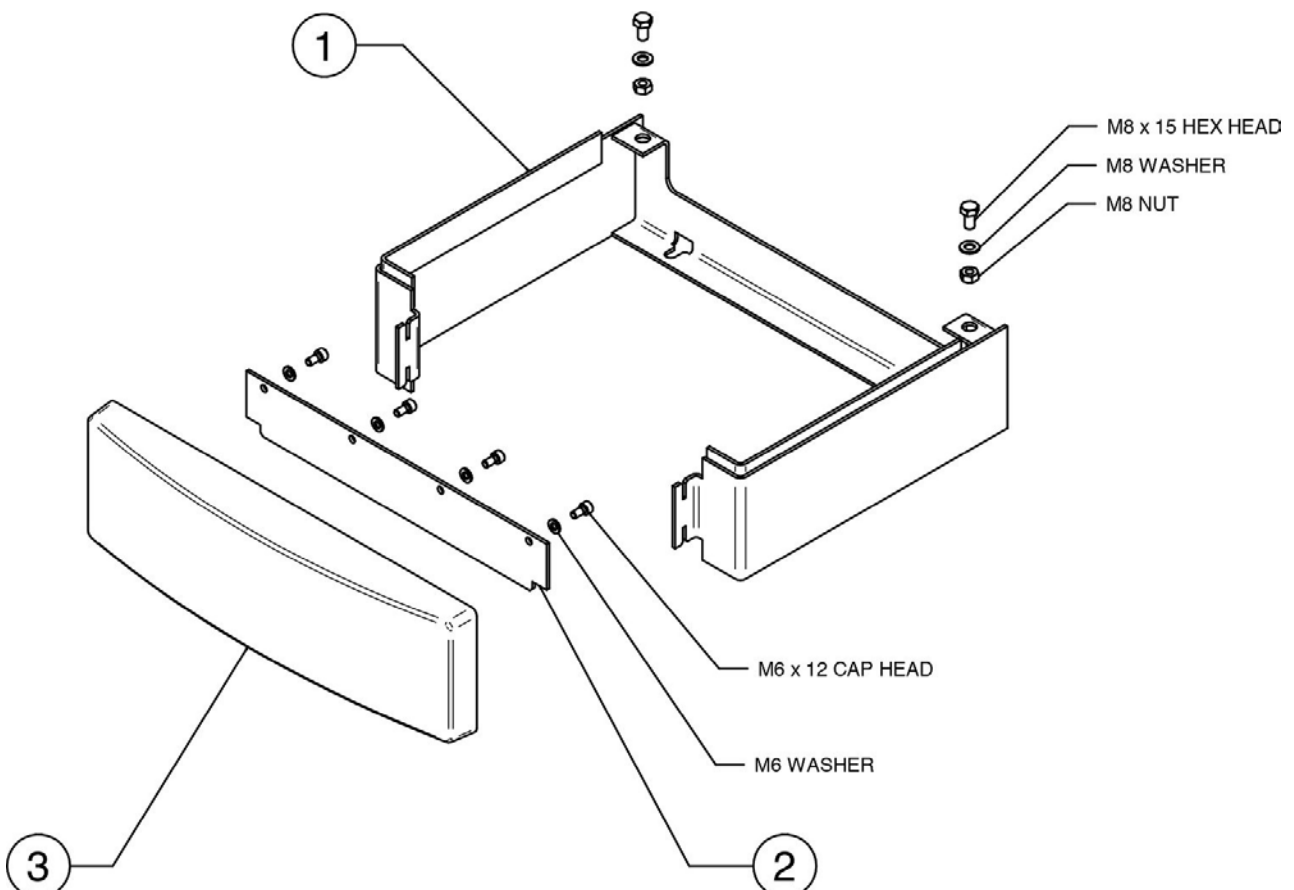

Drawing: PR10932-2

Do you have the correct appliance?

Before ordering your parts please ensure you have selected the correct appliance. To properly identify your appliance you will need to know your serial number and/or model number. Please use the following guide to help locate your data badge which contains your serial and model number information.



[Read More](#)

Ref.	Product Code		Description	
1	VG-MEDSL-BP		Vogue Medium Slimline Plinth Assembly including parts 2 and 3	
2	N/A		See part 1	This part is not currently available.
3	CA7811		Vogue Medium Cast Plinth	
	M08NUTO		M8 Nut - Single Nut	

Drawing: PR10851-2

Do you have the correct appliance?

Before ordering your parts please ensure you have selected the correct appliance. To properly identify your appliance you will need to know your serial number and/or model number. Please use the following guide to help locate your data badge which contains your serial and model number information.

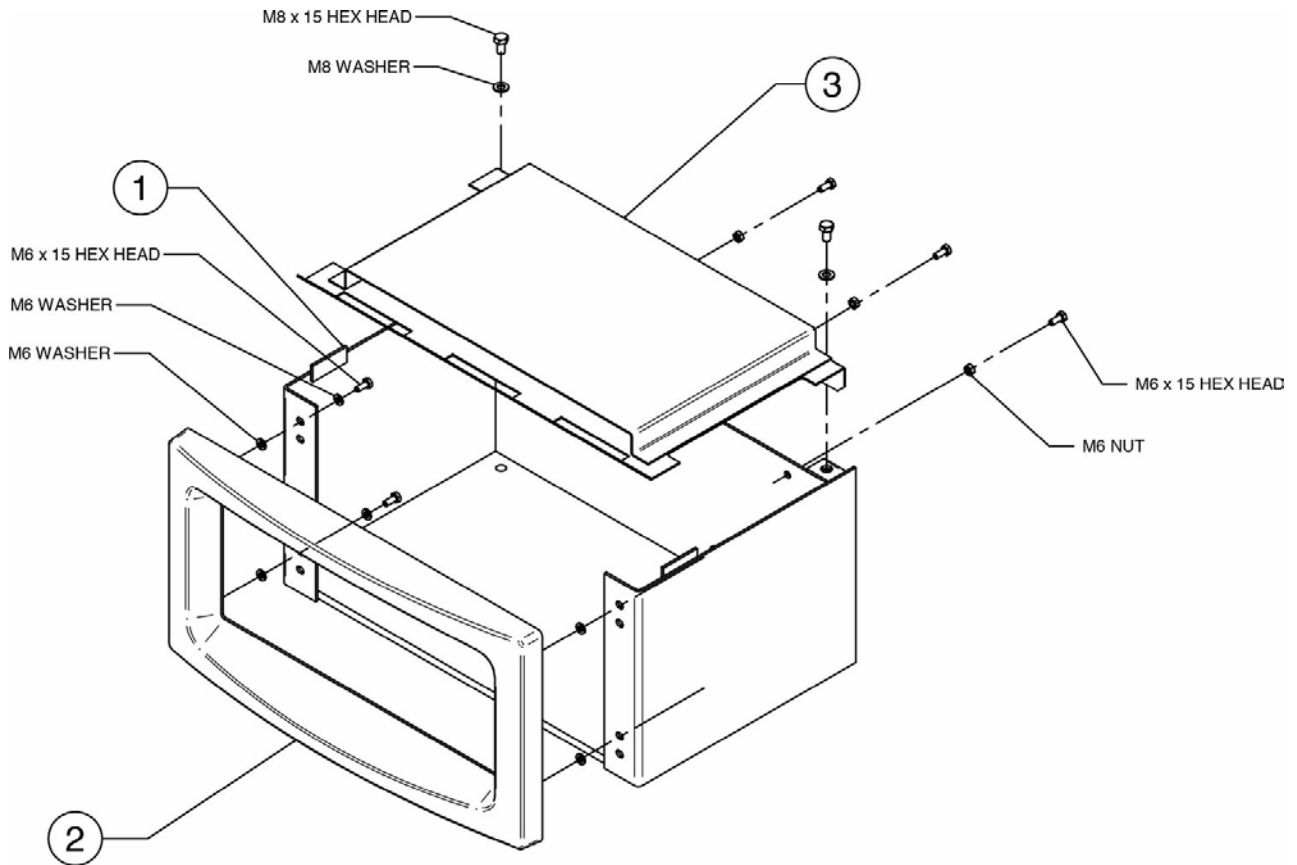

Read More

Ref.	Product Code	Description	Price (inc VAT)
------	--------------	-------------	-----------------

Drawing: PR10855-3

Do you have the correct appliance?

Before ordering your parts please ensure you have selected the correct appliance. To properly identify your appliance you will need to know your serial number and/or model number. Please use the following guide to help locate your data badge which contains your serial and model number information.