

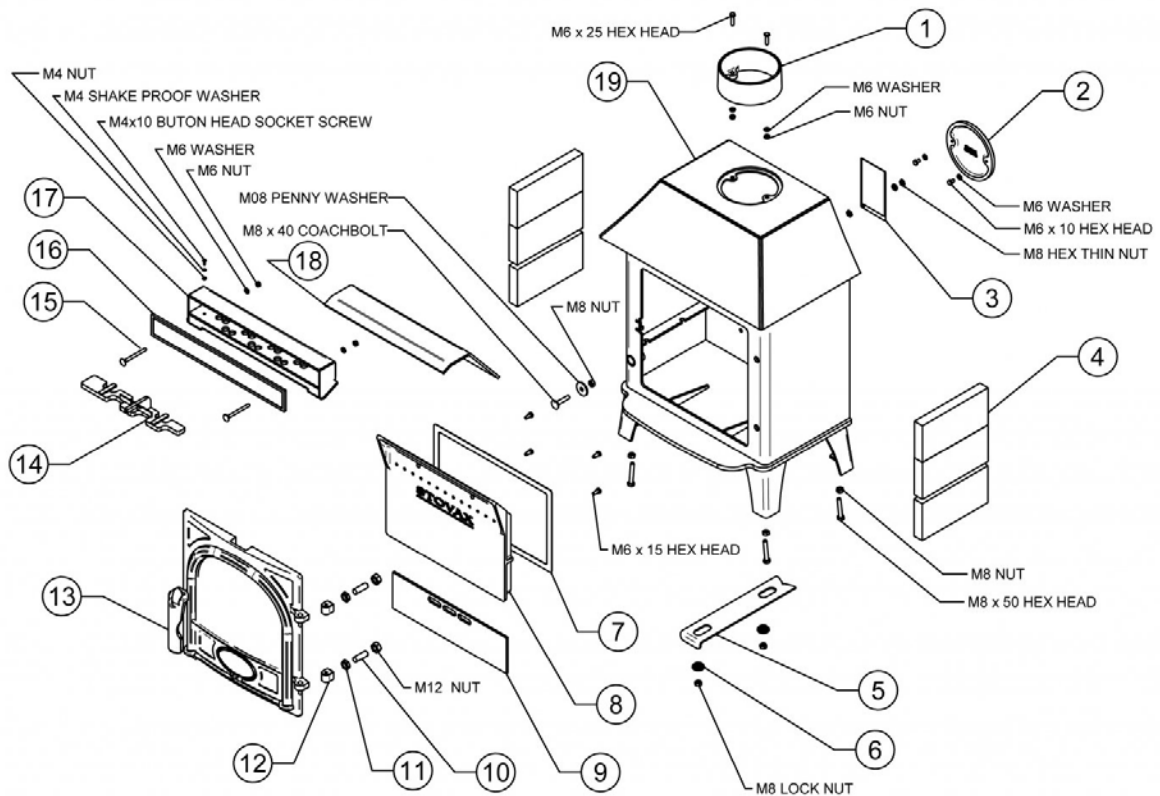



















Stockton 11 Wood Burning Stove Low Canopy 1 Door MK2

stovaxspares.com/appliance/stoves/stockton-stoves/stockton-11-wood-burning-stoves/low-canopy/serial-



[Read More](#)

Ref.	Product Code		Description
1	<u>CA7687</u>		Stockton 7/8/11/14/County/Devon/Exe/CL8 Mk2 6" Flue Adapter
2	<u>CA7686</u>		Stockton 7/8/11/14/CL8 Mk2 6" Blanking Plate
3	<u>ME500717</u>		Data Plate Mount
4	<u>CE7928</u>		Stockton 11 Mk2 Side Firebrick Please note: 3 Bricks Required Each Side (300x110x25mm)
5	<u>RA502882</u>		Stockton 11 HB/County 60HB Mk2 Secondary Air Control Slider
6	<u>SM32</u>		Stockton/View Mk2 CE Secondary Air Slider Bush
7	<u>4949</u>		10mm x 2mm Self Adhesive Tape Seal - 2m Pack 1730mm length required
8	<u>SL27</u>		Stockton 11 Cleanburn Chamber
9	<u>ME600841</u>		Stockton 11 Mk2 Wood Retaining Plate
10	<u>SM18</u>		M12 x 35mm Hinge Block Stud - Single Stud
11	<u>SM21</u>		M12 x 6mm Hinge Block Locking Nut - Single Nut
12	<u>SM10</u>		Stockton Hinge Block

Ref.	Product Code		Description	
13	<u>MEC9407</u>		Stockton 11 MK2 Complete Single Door Assembly	
14	<u>MEC9408</u>		Stockton 11 Mk2 Airwash Control Slider	
15	<u>M0675CBLT</u>		M6 x 75mm Coach Bolt - Single Bolt	
16	<u>4949</u>		10mm x 2mm Self Adhesive Tape Seal - 2m Pack 1245mm length required	
17	<u>MEC9345</u>		Stockton 11 Mk2 Airwash Control Chamber	
18	<u>SL26</u>		Stockton 11 Mk1 Baffle Plate	
19	<u>N/A</u> <u>Carcass</u>		Welded Carcass Assembly	This part is not serviceable and cannot be ordered as a spare.



Drawing: PR9398-1



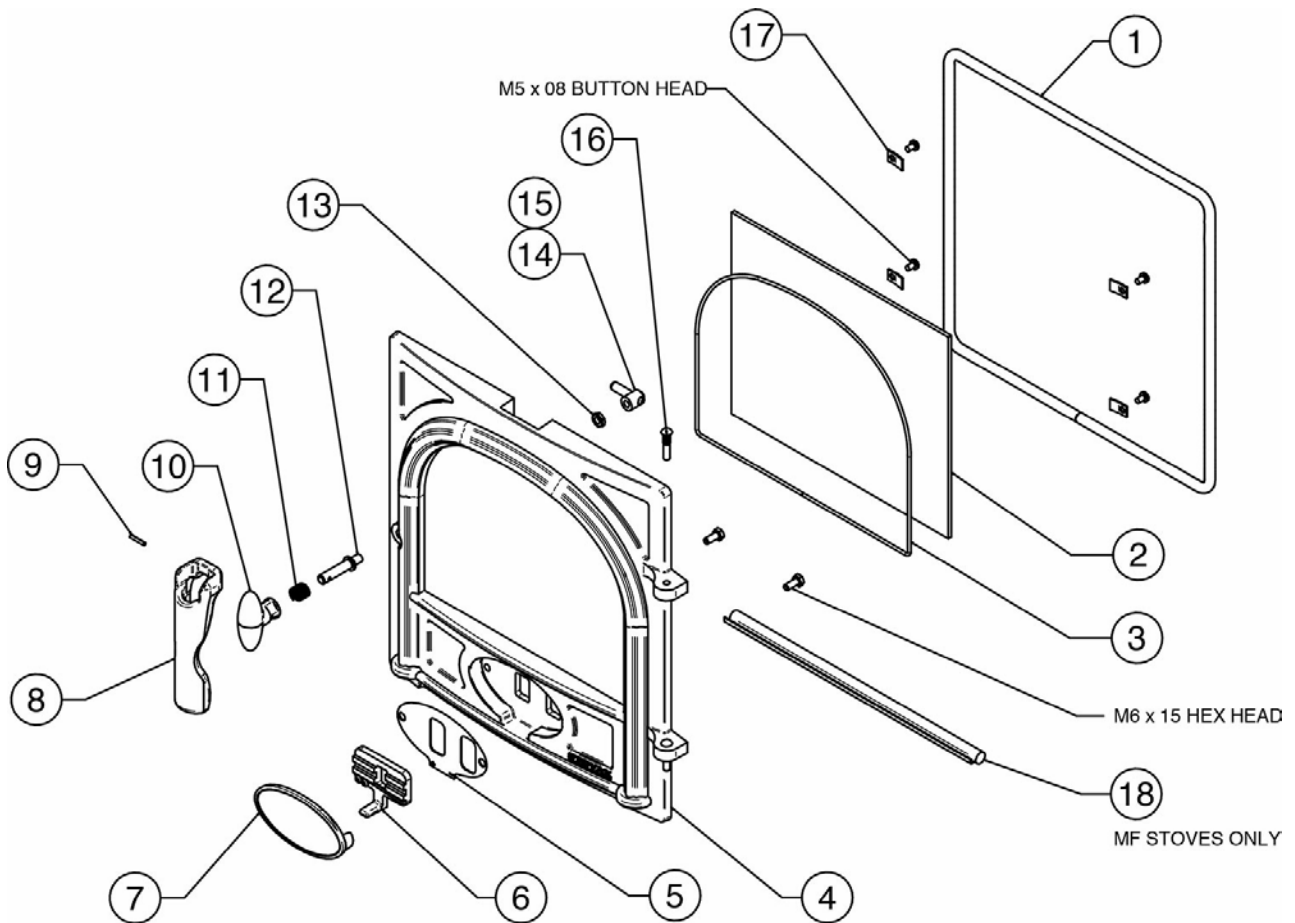









Do you have the correct appliance?



Before ordering your parts please ensure you have selected the correct appliance. To properly identify your appliance you will need to know your serial number and/or model number. Please use the [following guide](#) to help locate your data badge which contains your serial and model number information.



[Read More](#)[Read More](#)[Read More](#)

Ref.	Product Code		Description
1	<u>5700</u>		13mm Black Door Rope Seal with Adhesive - 2m Pack 1990mm length required
2	<u>GL0102</u>		Stockton 11 Mk1 Door Glass Dimensions: 495x309x4mm
3	<u>4975</u>		3mm Glass Rope Seal with Adhesive - 2m Pack 1445mm length required

Ref.	Product Code		Description	
4	<u>N/A</u>		For complete door assembly see Main Assembly page	This part is not currently available.
5	<u>ME600683</u>		Stockton 8 Mk2/5 Wide Air Control Slider Plate	
6	<u>MEC9099</u>		Stockton 8 Mk2/5 Wide Air Control Slider	
7	<u>SM3</u>		Stockton 8/11/5 Wide Air Control Cover Plate	
8	<u>CA7677</u>		Stockton/Yeoman Mk2 Multifunction Door Tool	
9	<u>YM-F00004</u>		3mm x 18mm Spiral Pin - Single Pin	
10	<u>MEC9362</u>		Complete Door Knob And Spindle Assembly	
11	<u>FA9017</u>		Airwash Spinner Spring	
12	<u>ME600844</u>		Stockton 11 Mk2 Door Spindle	
13	<u>RVAC111</u>		M8 Hex Thin Nut - Single Nut	
14	<u>MEC9020</u>		Stockton/Yeoman Traditional Mk2 Door Spindle Catch	
15	<u>N/A Assembly</u>		See part 10	This part cannot be ordered individually and is sold as part of an assembly.





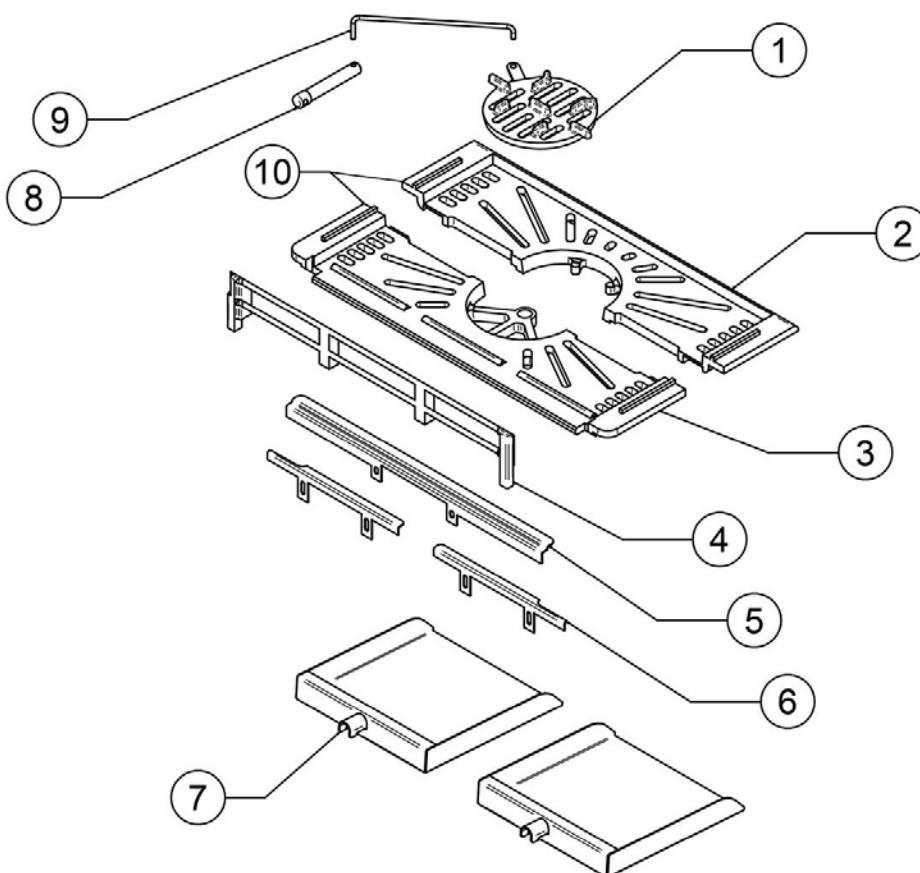

Ref.	Product Code		Description
16	<u>SM20</u>		Stockton Door Hinge Pin
17	<u>RA502594</u>		Stockton Mk2 Glass Clip
18	<u>Rope Seal</u>		This part is for multi-fuel appliances only.

Drawing: PR9308-2

Do you have the correct appliance?

Before ordering your parts please ensure you have selected the correct appliance. To properly identify your appliance you will need to know your serial number and/or model number. Please use the [following guide](#) to help locate your data badge which contains your serial and model number information.



Ref.	Product Code		Description
1	<u>SMN37</u>		Stockton 3/4/5/6/7/8/11/CL3/CL5/CL8 Centre Grate
4	<u>CA7690</u>		Stockton 11 Log Guard
5	<u>RA502997</u>		Stockton 11 Mk2 Single Door Mid Door Seal Bracket Single door only
6	<u>ST11D2DDS</u>		Stockton 11 Double Door Mid Door Seal Brackets Double door only.
7	<u>MEC9400</u>		Stockton 11 Mk2 Ashpan
8	<u>ME600650</u>		Stockton 3/4/5/6/7/8/11 MF Mk2 Riddling Bar
9	<u>RA502889</u>		Stockton 11 Mk2 Riddling Bar

Drawing: PR9916

Do you have the correct appliance?

Before ordering your parts please ensure you have selected the correct appliance. To properly identify your appliance you will need to know your serial number and/or model number. Please use the [following guide](#) to help locate your data badge which contains your serial and model number information.